

SHIGEMATSU WORKS CO., LTD.

Donning Instruction for Model DD01V-N95-1 Filtering Facepiece

IMPORTANT

Users must read the instructions and use the respirator following these instructions.

FITTING

●Check before donning

Wearer must check the following points before use.

If you find any failure or defect, please replace the respirator with a new one.

1. Check that the respirator is free from fissures or holes.
2. If the respirator is stained or dirty.
3. Check that the straps have a sufficient elasticity.

●Donning Procedures

1. The respirator is folded in rectangular shape.

Loosen the straps and unfolded the respirator.

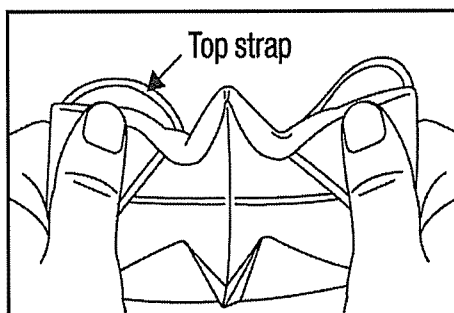
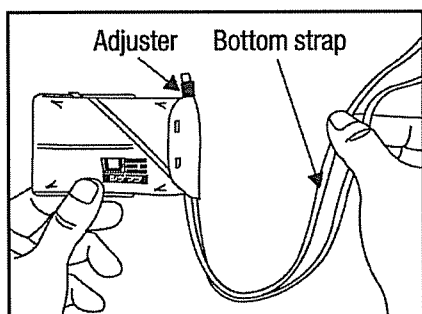

2. Flatten the curved part in the middle of the shape retaining tape by softly pressing.

(as shown in Fig)

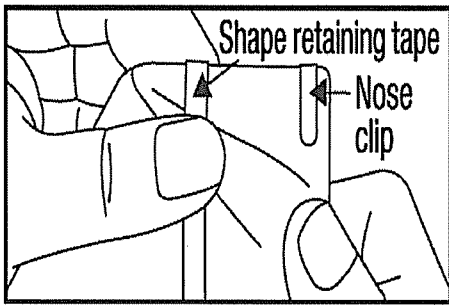

3. Put the bottom strap around your neck.

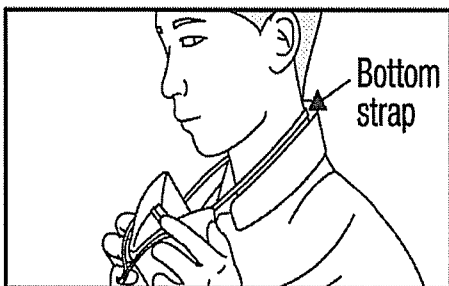

4. Set the top strap to the outer side of the respirator and while holding the both ends of the respirator with both hands, put the respirator over the nose and mouth.

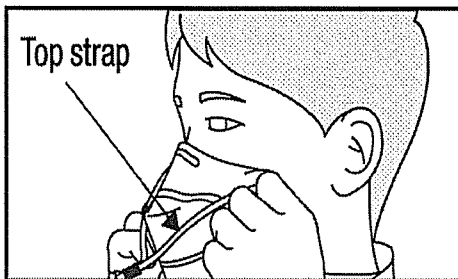

5. Hold the respirator with one hand and put the top strap over the back of your head with the other hand.

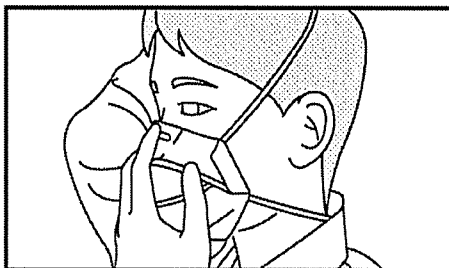

6. Pull the adjuster for the top strap, if necessary, to adjust the length of the strap so that the respirator can be attached firmly to your face.

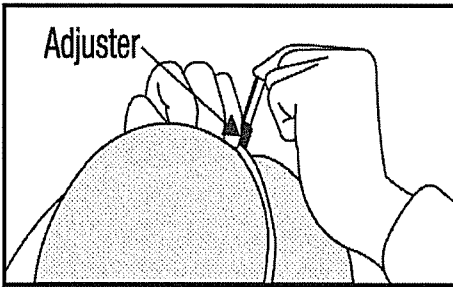

7. Adjust each tension of the top and bottom straps so that the respirator can fit securely to your face.

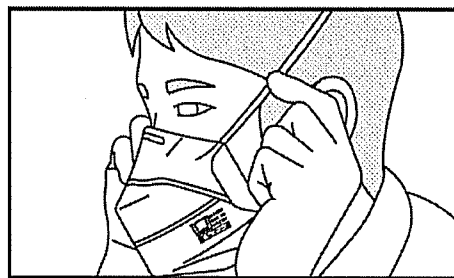
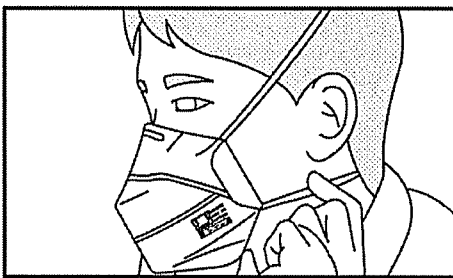

8. Press the nose clip with fingers of both hands so that the respirator can be attached firmly to your nose.

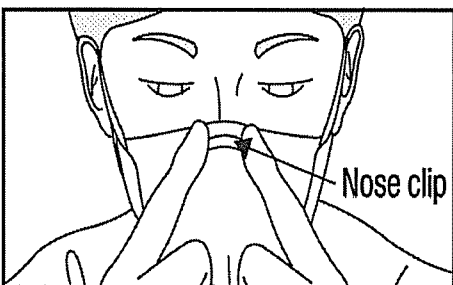

●Proper fitting

In order to achieve the original performance of the respirator, the respirator must have best fit. The user is required to be fit tested according to OSHA 29 CFR 1910.134 either qualitatively or quantitatively prior to use. Conduct a fit check following this procedure every time you put on the respirator.

1. Wear the respirator in the same manner as you actually conduct during work.
2. Cover the respirator with two hands and inhale sharply. If it is not possible to cover the respirator with both hands, use a polyethylene sheet to cover the surface of the respirator, holding it down with both hands and inhale sharply.
3. Check that no air leaks through respirator-to-face seal when you inhale sharply. If you feel air leakage, adjust the position of respirator and/or tension of straps until the air leakage stops.



●For your reference

If your face is too small to fit properly to your chin, it is recommended to put the bottom strap over the back of your head as shown in the figure below so that the respirator is tightly fitted around the chin.

